

Temperature Difference Transmitter ETSD



- Simple measurement of temperature differences
- Self-built plug including
- large distance between the two sensors is possible (4-wire connection)
- Infinitely adjustably rotatable cable outlet for clean alignment
- Different characteristic curves are possible

Characteristics

Temperature difference measuring at two process locations, with very low installation effort and compliant 4..20 mA 2-wire system. The ETSD1 und ETSD2 sensors measure temperatures T1 and T2 at the respective process locations, each using a platinum resistance sensor. In addition to the sensor, ETSD1 contains a microcontroller circuit which calculates the difference between the two temperatures (T1-T2), and outputs it via an amplifier as a 4..20 mA signal. Two outputs with different characteristic curves are available as standard.

Altogether the circuit requires < 4 mA, and so it was possible to implement a 2-wire system (including wire break recognition).

Technical data

Sensor	platinum resistance sensor	
Process connection	male thread G 1/4 A.. G 1/2 A, union nut G 3/4 or 3-clamp connection	
Metering range	0..20 K, 0..50 K	
Measurement accuracy	±1 K	
Reproducibility	±0.1 K	
Pressure	Lance shape	PN 25
	Compact construction	PN 100
Media temperature T1	Lance shape	-20..+80 °C optionally -20..+100 °C with gooseneck
	Compact construction	-20..+80 °C optionally -20..+100 °C with gooseneck
Media temperature T2	Lance shape	-20..+120 °C
	Compact construction	-20..+100 °C
Ambient temperature	-20..+70 °C	
Dynamic (τ)	3 s	
Supply voltage	15..30 V DC	
Materials medium-contact	1.4571	
Materials, non-medium-contact	CW614N plated, PP	
Analog output	4..20 mA (two-wire)	
Reversal polarity protected	yes	
Electrical connection	plug DIN 43650-A / ISO 4400	
Ingress protection	IP 65	
Weight	0.45 kg	
Conformity	CE	

Produktinformation

Sensors and Instrumentation

Ranges

Metering ranges of 20 Kelvin difference and 50 Kelvin difference are available as standard. Any other required differences are available on request.

Every temperature difference range is available with two different characteristic curves:

Characteristic curve A: The absolute value of the difference T1-T2 is output, i.e. it cannot be recognised from the signal which of the two temperatures is the higher. Difference 0 corresponds to 4 mA. If the maximum difference is exceeded, the output signal can show larger values than 20 mA (max. 24 mA).

Example:

Characteristic curve A for metering range 20 Kelvin difference

Typ A

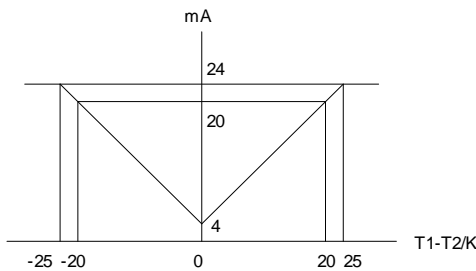

Characteristic curve B: The output signal is proportional to the difference T1-T2. The difference 0 Kelvin can be assigned to any desired current value in the range 4..20 mA, so that negative differences can also be represented.

If the intended metering range is left, the output signal can show smaller values than 4 mA (min. 3.6 mA) or larger values than 20 mA (max. 21 mA).

Example:

Characteristic curve B for metering range 20 Kelvin difference
 Difference of 0 Kelvin corresponds to 4 mA

Typ B

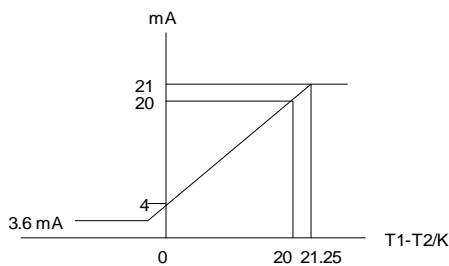

Wiring

plug DIN 43650-A / ISO 440

round plug connector
 M12x1

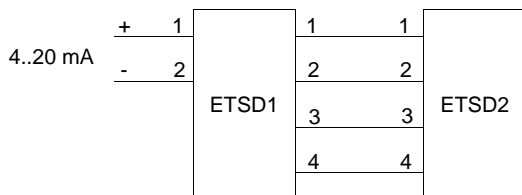

Dimensions

Lance shape

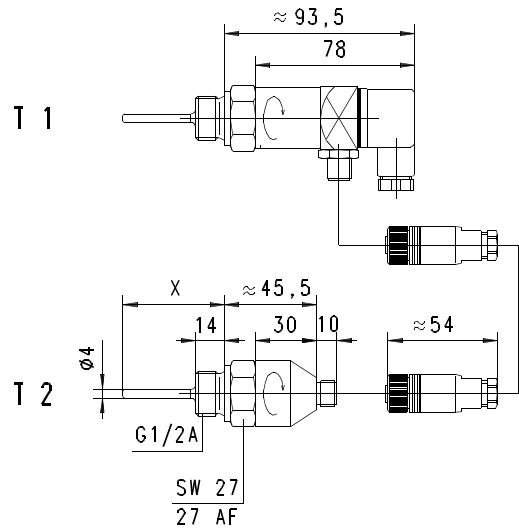

Lance type	Length X	Screw-in thread
..050..	50	G 1/2 A
..100..	100	G 1/2 A
..150..	150	G 1/2 A
..200..	200	G 1/2 A

Produktinformation

Sensors and Instrumentation

Compact sensor

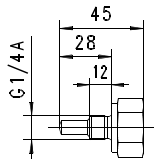

Screw-in sensor G 1/4 A
 Type ..028..

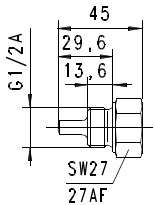

Screw-in sensor G 1/2 A
 Type ..029..

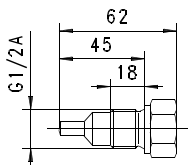

Screw-in sensor G 1/2 A
 Type ..045..

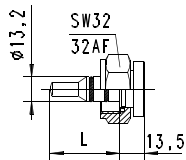

Sensor with union nut for
 T-piece G 3/8..G 1/2
 Type ..031.. (L = 31 mm)
 or
 T-piece G 3/4..G 2
 Type ..037.. (L = 37 mm)

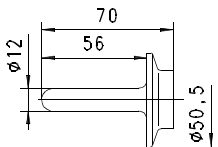

Sensor for Tri-clamp connection
 Type ..056..

"Gooseneck" option for higher temperatures
 (available for lance and compact shape)

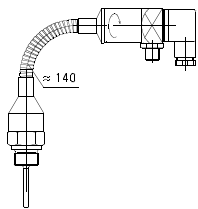

Handling and Operation

Installation

Sensors with screw-in threads are screwed into a T-piece or a nozzle in the pipework, using a suitable flat seal (e.g. Klingerit). Sensors with a union nut are mounted in a T-piece (see separate product information). Use only a hexagonal spanner to tighten. It should be ensured that the sensor tip is located fully in the medium flow, and does not push against the wall of the pipe. After this, the upper part of the sensor with the connector output can be turned steplessly in order to align the cable outlet.

Ordering code

Sensors ETSD1 and ETSD2 are what you should order for a complete temperature difference measuring point!

ETSD1

ETSD1 - 1. 2. 3. 4. 5. 6.

Option =

1. Zero point		
00-	T1-T2= 0 Kelvin corresponds to 4 mA (relevant only for characteristic curve B)	
2. Difference		
020	T1-T2= 20 Kelvin corresponds to 20 mA	
050	T1-T2= 50 Kelvin corresponds to 50 mA	
3. Connection material		
K	Stainless steel 1.4571	
4. Process connection		
050	lance length	50 mm Ø 4 mm
100		100 mm Ø 4 mm
150		150 mm Ø 4 mm
200		200 mm Ø 4 mm
028	sensor length	28 mm (G 1/4 A)
029		29.6 mm (G 1/2 A)
045		45 mm (G 1/2 A)
031	sensor for	T-piece G 3/8..G 1/2
037		T-piece G 3/4..G 2
5. Characteristic curve		
A	A	
B	B	
6. Option		
H	<input type="checkbox"/> gooseneck model	

ETSD2

ETSD2 - 1. 2.

1. Connection material		
K	stainless steel 1.4571	
2. Process connection		
050	lance length	50 mm Ø 4 mm
100		100 mm Ø 4 mm
150		150 mm Ø 4 mm
200		200 mm Ø 4 mm
028	sensor length	28 mm (G 1/4 A)
029		29.6 mm (G 1/2 A)
045		45 mm (G 1/2 A)
031	sensor for	T-piece G 3/8..G 1/2
037		T-piece G 3/4..G 2

Accessories

- T-piece type TS-2... Thread G 3/8..G 2
- Cable/round plug connector (KB...) see additional information "Accessories"
- Evaluation electronics OMNI-TA
- Device configurator ECI-2